

# SECONDARY MEDICAL FURNITURE

## SEKUNDARNA MEDICINSKA OPREMA



CATALOGUE 2012  
KATALOG 2012

**medico**  
engineering

Medicoengineering d.o.o.  
Prevale 1  
1236 Trzin

Tel: +386 (0)1 530 26 00  
Fax: +386 (0)1 530 26 02  
e-mail: info@medico-eng.com

[www.medico-eng.com](http://www.medico-eng.com)

# TABLE OF CONTENTS

## KAZALO

### EQUIPMENT ROUND PLACES

- Unclean area equipment
- Operating room equipment

### EQUIPMENT ROUND PRODUCTS

- Multi purpose trolley with accessories
- Documentation trolley
- Container trolley
- Trolley for transport and cleaning of mattresses
- Trolley for transport and cleaning of antidecubital cushions
- Trolley for storage and transport sterile materials
- Trolley for paper
- Trolley for or footwear
- Plaster trolley
- Trolley for transport and deposit of bed pans
- Instrument trolley
- Anesthesia trolley
- Trolley for transport of the deceased
- Baby changing station - trolley
  
- Worktables - cabinets
- Desk for baby care
- Stainless steel desk for baby care
  
- Working tables
- Hydraulic mayo table
- Packing table for dry materials
- Double packing table for dry materials
- Working table for wet materials
- Working table for wet materials with sinks
- Dissecting table
  
- Racks and shelves
- Wall shelves
- Wall profiles with baskets and shelves
- Shelving system
  
- Stainless steel cabinets
- Bedpan washer disinfectant blatex
- Dump basin
- Surgical scrub sinks
- Soap / disinfectant dispenser
- Sterile brushes dispenser
- Waste bag holder
- Heated bowl holder
- Barrier curtains
- Multifunctional handrails
- Stainless steel railings

### OPREMA PO PROSTORIH

- Pohištvo in oprema za nečiste prostore
- Pohištvo in oprema za operacijske dvorane

### OPREMA PO PROIZVODIH

- Večnamenski vozički z dodatki
- Voziček za dokumentacijo
- Kontejnerski voziček
- Voziček za prevoz in čiščenje vzmetnic
- Voziček za prevoz in čiščenje antidekubitivnih blazin
- Voziček za skladiščenje in prevoz sterilnega materiala
- Voziček za papir
- Voziček za operacijsko obutev
- Voziček za mavčenje
- Voziček za prevoz in deponijo nočnih posod
- Voziček za inštrumente
- Anestezijski voziček
- Voziček za prevoz umrlih
- Otroški previjalni voziček
  
- Delovni pulti - omare
- Pult za nego otroka
- Pult za nego otroka iz nerjavečega jekla
  
- Delovne mize
- Hidravlična instrumentarska miza - mayo
- Pakirna miza za suhe materiale
- Dvojna pakirna miza za suhe materiale
- Delovna miza za mokre materiale
- Delovna miza za mokre materiale s pomivalnimi koriti
- Secirna miza
  
- Regali in police
- Stenske police
- Stenski obešalni profili s košarami in policami
- Sistemski regali
  
- Omare iz nerjavečega jekla
- Dezinfekcijski pralni stroj in izlivnik
- Izlivnik
- Kirurška korita
- Dispenser za milo / razkužilo
- Dispenser za sterilne ščetke - sterilka
- Držalo za PVC vrečke
- Prevozno stojalo z grelcem in posodo
- Pregradne zavese
- Večnamenska oprijemala
- Ograje iz nerjavečega jekla

# UNCLEAN AREA EQUIPMENT

## POHIŠTVO IN OPREMA ZA NEČISTE PROSTORE

### Furniture and equipment for unclean areas

- Cabinets (wall cabinets, open medical cabinets, medical cabinets with different types of doors, cabinets for urin jars storage...)
  - Working tables (with or without sinks)
  - Shelves
  - Bedpan washers
  - Dump basins
  - Soap and disinfectant dispensers
  - Wire baskets
- 
- All equipment is made of stainless steel AISI 304
  - All equipment is made in various standard sizes or according to order



### Pohištvo in oprema za nečiste prostore

- Omare (stenske omare, odprte medicinske omare, medicinske omare z različnimi tipi vrat, omare za shranjevanje urinskih vrčev...)
  - Delavni pulti (z ali brez korit)
  - Police in regali
  - Pomivalci nočnih posod, urinskih posod in ostalega pribora
  - Izlivna korita
  - Milni in dezinfekcijski dispenzerji
  - Žičnate košare
- 
- Vsa oprema je izdelana iz kakovostnega nerjavečega jekla AISI 304
  - Vsa oprema je izdelana v različnih standardnih dimenzijah ali po željah in potrebah naročnika

# OPERATING ROOM EQUIPMENT

## POHIŠTVO IN OPREMA ZA OPERACIJSKE DVORANE

### Equipment for operating theatres

- Cabinets, rack systems and shelves
  - Heated bowl holder
  - Surgeon's stools and chairs
  - Various trolleys
  - Mayo tables
  - Surgeon's steps (single, double)
  - Wire baskets
  - IV stands
  - Bowl holders
  - Mobile binds
  - Negatoscopes
- 
- All equipment is made of stainless steel AISI 304
  - All equipment is made in various standard sizes or according to order

### Oprema za operacijske sobe

- Omare, regali in police
  - Prevozna stojala z grelcem in posodo
  - Operacijski stoli
  - Večnamenski vozički
  - Instrumentarske mize (mayo)
  - Kirurške stopnice (enojne, dvojne)
  - Žičnate košare
  - Infuzijska stojala
  - Stojala za posode (enojna, dvojna)
  - Mobilni zastori
  - Negatoskopi
- 
- Vsa oprema je izdelana iz kakovostnega nerjavečega jekla AISI 304
  - Vsa oprema je izdelana v različnih standardnih dimenzijah ali po željah in potrebah naročnika





# MULTI PURPOSE TROLLEY WITH ACCESSORIES

## VEČNAMENSKI VOZIČKI Z DODATKI

- Trolleys are robust and durable, light and easy to manoeuvre
  - Frame, handle and railings are made of stainless steel AISI 304
  - Shelves are made of laminate
  - All edges are rounded
  - 4 or more wheels, at least 2 with brakes
  - PVC bumpers above the wheels
  - Non marking, noiseless rubber on wheels
  - Trolleys are made in different dimensions and types
- 
- Accessories: drawers, shelves, bars for equipment fitting, bag-holder frame, IV stand, various wire baskets, containers for clean and dirty instruments...
- 
- All equipment is made in various standard sizes or according to order
- 
- Usage: hospitals, clinics, pharmacy, nursery homes, schools, kindergardens, operating rooms, surgery, veterinary facilities...
- 
- 
- Vozički so robustni, trpežni, lahki in enostavni za manevriranje
  - Okvir, ročajji in ograjice so izdelani iz kakovostnega nerjavečega jekla AISI 304
  - Police so izdelane iz laminata ali nerjavečeha jekla
  - Vsi robovi so zaokroženi
  - 4 ali več koles, vsaj 2 z zavorami
  - PVC odbijači na kolesih
  - Kolesa iz neslišne gume, ki ne puščajo sledi
  - Vozički so različnih dimenzij in vrst
- 
- Dodatna oprema: predali, police, palice za pritrditev opreme, nosilec za vrečke, infuzijsko stojalo, različne žičnate košare, posodice za čiste in umazane instrumente...
- 
- Vsi vozički so izdelani v različnih standardnih dimenzijah ali po željah in potrebah naročnika
- 
- Uporaba: bolnišnice, ambulante, lekarne, negovalni domovi za ostarele, šole, vrtci, operacijske dvorane, kirurgija, veterina, farmacija...



# DOCUMENTATION TROLLEY

## VOZIČEK ZA DOKUMENTACIJO

- Trolleys are robust and durable, light and easy to manoeuvre
  - Frame, handle and railings are made of stainless steel AISI 304
  - Top surface and shelves are made of laminate
  - All edges are rounded
  - 4 wheels Ø 125 mm, 2 with brakes
  - Non marking, noiseless rubber on wheels
  - PVC bumpers above the wheels
  - Drawers with bottom opening
  - Drawers for storing patient documentation folders
  - Drawers for hanging documentation folders or patient x-ray images
- Dimensions: 650 (+ 70 handle) x 1050 x 500 mm



- Voziček je robusten, trpežen, lahek in enostaven za manevriranje
  - Ogradje, ročaj za potiskanje in predali so izdelani iz kakovostnega nerjavečega jekla AISI 304
  - Stranice in zgornja površina so izdelane iz laminata
  - Vsi robovi vozička so zaokroženi
  - 4 kolesa Ø 125 mm, 2 z zavoro
  - Kolesa iz neslišne gume, ki ne puščajo sledi
  - PVC odbijači na robovih spodnjega dela vozička
  - Predali z odpiranjem od spodaj
  - Predali za shranjevanje map s pacientovo dokumentacijo
  - Prostor za obešanje map za pacientovo dokumentacijo oz. rentgenskih slik
- Dimenzije: 650 (+ 70 ročaj) x 1050 x 500 mm

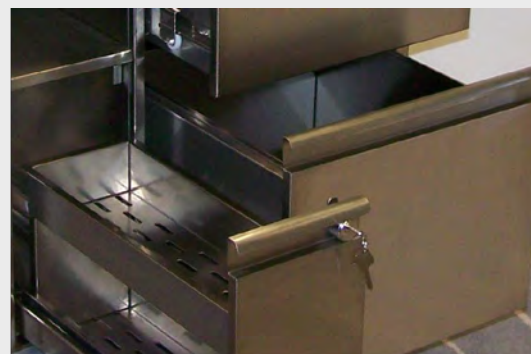

# CONTAINER TROLLEY

## KONTEJNERSKI VOZIČEK

- Trolleys are robust and durable, light and easy to manoeuvre
  - Trolley is made of stainless steel AISI 304
  - Two shelves inside of the trolley
  - Handle for pushing on the side of trolley
  - All edges are rounded
  - 4 wheels Ø 200 mm, 2 with brakes
  - Door opening for 270°
- 
- Dimensions: 1225 x 1350 x 710 mm



- Voziček je robusten, trpežen, lahek in enostaven za manevriranje
  - Voziček je izdelan iz kakovostnega nerjavečega jekla AISI 304
  - V notranjosti vozička sta dve polici
  - Na strani vozička je ročaj za potiskanje
  - Vsi robovi vozička so zaokroženi
  - 4 kolesa Ø 200 mm, 2 z zavoro
  - Odpiranje vrat za 270°
- 
- Dimenzije: 1225 x 1350 x 710 mm



# TROLLEY FOR TRANSPORT AND CLEANING OF MATTRESSES

## VOZIČEK ZA PREVOZ IN ČIŠČENJE VZMETNIC

- Trolley is robust and durable, light and easy to manoeuvre
- Made is entirely of stainless steel AISI 304
- All edges are rounded
- 4 wheels Ø 125 mm, 2 with brakes
- PVC bumpers above the wheels
- Non marking, noiseless rubber on wheels
- Used for transport and cleaning of mattresses



- Voziček je robusten, trpežen, lahek in enostaven za manevriranje
- Voziček je v celoti izdelan iz kakovostnega nerjavečega jekla
- AISI 304
- Vsi robovi so zaokroženi
- 4 kolesa, Ø 125 mm, 2 z zavorami
- PVC odbijači na kolesih
- Kolesa iz neslišne gume, ki ne puščajo sledi
- Uporablja se za prevoz in čiščenje vzmetnic



# TROLLEY FOR TRANSPORT AND CLEANING OF ANTIDECUBITAL CUSHIONS

## VOZIČEK ZA PREVOZ IN ČIŠČENJE ANTIDEKUBITUSNIH BLAZIN

- Trolley is robust and durable, light and easy to manoeuvre
- Made is entirely of stainless steel AISI 304
- All edges are rounded
- 4 wheels Ø 125 mm, 2 with brakes
- PVC bumpers above the wheels
- Non marking, noiseless rubber on wheels
- Used for transport and cleaning of antidecubital cushions



- Voziček je robusten, trpežen, lahek in enostaven za manevriranje
- V celoti je izdelan iz kakovostnega nerjavečega jekla AISI 304
- Vsi robovi so zaokroženi
- 4 kolesa Ø 125 mm, 2 z zavorami
- PVC odbijači na kolesih
- Kolesa iz neslišne gume, ki ne puščajo sledi
- Uporablja se za prevoz in čiščenje antidekubitusnih blazin

# TROLLEY FOR STORAGE AND TRANSPORT STERILE MATERIALS

## VOZIČEK ZA SKLADIŠČENJE IN PREVOZ STERILNEGA MATERIALA

- Trolley is robust and durable, light and easy to manoeuvre
- Made is entirely of stainless steel AISI 304
- All edges are rounded
- 4 wheels Ø 125 mm, 2 with brakes
- PVC bumpers above the wheels
- Non marking, nislless rubber on wheels
- Used for transport and storage of modular sterilization baskets inside and outside of central sterilization unit
- Stainless steel shelf on the bottom protects baskets from dirt during transport
- Can be cleans and disinfected in thermodisinfectior
- Capacity:
  - 5 large sterilization baskets 585 x 395 x 195 mm
  - 10 small sterilization baskets 585 x 395 x 100 mm
- Dimensions of trolley: 658 x 435 x 1530 mm



- Voziček je robusten, trpežen, lahek in enostaven za manevriranje
- V celoti je izdelan iz kakovostnega nerjavečega jekla AISI 304
- Vsi robovi so zaokroženi
- 4 kolesa Ø 125 mm, 2 z zavornami
- PVC odbijači na kolesih
- Kolesa iz neslišne gume, ki ne puščajo sledi
- Uporablja se za prevoz in skladiščenje modularnih košar za sterilizacijo, znotraj in zunaj centralne enote za sterilizacijo
- Polica iz nerjavečega jekla na dnu vozička, ščiti pred umazanijo med prevozom
- Lahko se očisti in dezinficira v termodezinfektorju
- Kapaciteta:
  - 5 visokih modularnih košar za sterilizacijo 585 x 395 x 195 mm
  - 10 nizkih modularnih košar za sterilizacijo 585 x 395 x 100 mm
- Dimenzije vozička: 655 x 400 x 1520 mm

# TROLLEY FOR PAPER

## VOZIČEK ZA PAPIR

- Trolley is robust and durable, light and easy to manoeuvre
  - Made is entirely of stainless steel AISI 304
  - All edges are rounded
  - 4 wheels Ø 125 mm, 2 with brakes
  - PVC bumpers above the wheels
  - Non marking, noiseless rubber on wheels
  - Paper holders are in the different heights fo different sizes of paper sheets
- 
- Dimensions: 1300 x 340 x 730/930 mm



- Voziček je robusten, trpežen, lahek in enostaven za manevriranje
  - Voziček je v celoti izdelan iz kakovostnega nerjavečega jekla AISI 304
  - Vsi robovi so zaokroženi
  - 4 kolesa Ø 125 mm, 2 z zavorami
  - PVC odbijači na kolesih
  - Kolesa iz neslišne gume, ki ne puščajo sledi
  - Nosilci za papir so različnih velikostih, na katerih hranimo papir različnih velikosti
- 
- Dimenzije: 1300 x 340 x 730/930 mm



# TROLLEY FOR OR FOOTWARE

## VOZIČEK ZA OPERACIJSKO OBUTEV

- Trolley is made entirely of stainless steel AISI 304
- Shelves for footware are removable
- 4 antistatic wheels, 2 with brakes
- Holds up to 24 pairs of OR footwear
- Dimensions: 900 x 650 x 1600 mm

- Voziček je v celoti izdelan iz kakovostnega nerjavečega jekla AISI 304
- Police za obutev so snemljive
- 4 antistatična kolesa, 2 z zavorami
- Shranite lahko do 24 parov operacijskih obuval
- Dimenzije: 900 x 650 x 1600 mm





# PLASTER TROLLEY

## VOZIČEK ZA MAVČENJE

- Trolleys are robust and durable, light and easy to manoeuvre
- Trolley is made entirely of stainless steel AISI 304
- 6 drawers, folding table, container and garbage bag holder
- All edges are rounded
- 4 antistatic wheels, 2 with brakes
- PVC bumpers above the wheels
- Non marking, noiseless rubber on wheels
  
- Dimensions:
  - Length: 1000 (+500 mm folding table + 350 mm bowl and bag frame)
  - Width: 600 mm
  - Height: 850 mm



- Vozički so robustni in trpežni, lahki in enostavni za manevriranje
- Vozički so v celoti izdelani iz kakovostnega nerjavečega jekla AISI 304
- 6 različnih predalov, zložljiva miza, zaboljnik in držalo za PVC vreče
- Vsi robovi so zaokroženi
- 4 antistatična kolesa, 2 z zavorami
- PVC odbijači nad kolesi
- Kolesa iz neslišne gume, ki ne puščajo sledi
  
- Dimenzije:
  - Dolžina: 1000 (+500 mm zložljiva miza + 350 mm posoda in okvir za vrečo)
  - Širina: 600 mm
  - Višina: 850 mm

# TROLLEY FOR TRANSPORT AND DEPOSIT OF BED PANS

## VOZIČEK ZA PREVOZ IN DEPONIRANJE NOČNIH POSOD

- Trolley is robust and durable, light and easy to manoeuvre
- Made is entirely of stainless steel AISI 304
- All edges are rounded
- 4 wheels Ø 100 mm, 2 with brakes
- PVC bumpers above the wheels
- Non marking, noiseless rubber on wheels
  
- Dimensions: 425 x 400 x 950 mm
- Capacity: 5 or 6 bedpans



- Voziček je robusten, trpežen, lahek in enostaven za manevriranje
- V celoti je izdelan iz kakovostnega nerjavečega jekla AISI 304
- Vsi robovi so zaokroženi
- 4 kolesa Ø 100 mm, 2 z zavornimi
- PVC odbijači na kolesih
- Kolesa iz neslišne gume, ki ne puščajo sledi
  
- Dimenzije: 425 x 400 x 950 mm
- Kapaciteta: 5 do 6 nočnih posod

# INSTRUMENT TROLLEY

## VOZIČEK ZA INŠTRUMENTE

- Trolley is robust and durable, light and easy to manoeuvre
- Trolley is made entirely of stainless steel AISI 304
- All edges are rounded
- 4 wheels Ø 100 mm, 2 with brakes
- PVC bumpers above the wheels
- Non marking, noiseless rubber on wheels
- 2 shelves, 10 instrument trays



- Voziček je robusten, trpežen, lahek in enostaven za manevriranje
- V celoti je izdelan iz kakovostnega nerjavečega jekla AISI 304
- Vsi robovi so zaokroženi
- 4 kolesa Ø 100 mm, 2 z zavorami
- PVC odbijači na kolesih
- Kolesa iz neslišne gume, ki ne puščajo sledi
- 2 polici, 10 inštrumentnih pladnjev

# ANESTHESIA TROLLEY

## ANESTEZIJSKI VOZIČEK

- Trolley is robust and durable, light and easy to manoeuvre
- Trolley is made entirely of stainless steel AISI 304
- All edges are rounded
- 4 wheels Ø 125 mm, 2 with brakes
- PVC bumpers above the wheels
- Non marking, noiseless rubber on wheels
- Drawers and three-sided gallery above the top surface



- Voziček je robusten, trpežen, lahek in enostaven za manevriranje
- V celoti je izdelan iz kakovostnega nerjavečega jekla AISI 304
- Vsi robovi so zaokroženi
- 4 kolesa Ø 125 mm, 2 z zavornimi
- PVC odbijači na kolesih
- Kolesa iz neslišne gume, ki ne puščajo sledi
- Predali in tristrani zaščitni okvir nad zgornjo površino



# TROLLEY FOR TRANSPORT OF THE DECEASED

## VOZIČEK ZA PREVOZ UMRLIH

- Trolley for transport of deceased is made entirely of stainless steel AISI 304
- Raised edges
- Top surface slightly tilted to allow the drainage of fluids via the drain in the middle
- 4 wheels Ø 200 mm, 2 with brakes
- Dimensions: 2000 x 680 mm
  
- Optional: cover lid



- Voziček za prevoz umrlih je v celoti narejen iz kakovostnega nerjavečega jekla AISI 304
- Dvignjeni robovi
- Zgornja površina je rahlo nagnjena proti sredini in omogoča odtekanje tekočin preko sredinskega odtoka
- 4 kolesa Ø 200 mm, 2 z zavorami
- Dimenzije: 2000 x 680 mm
  
- Možnost: pokrov

# BABY CHANGING STATION - TROLLEY

## OTROŠKI PREVIJALNI VOZIČEK

- Trolley is robust and durable, light and easy to manoeuvre
- Frame, handle and drawers are made of stainless steel ASI 340
- Top surface has a three-sided gallery and is made of ABS
- All edges are rounded
- 4 wheels Ø 125 mm, 2 with brakes
- PVC bumpers above the wheels
- Non marking, noiseless rubber on wheels
  
- Trolley can be made in different types and dimensions
- Accessories: drawers, baby changing cushions...



- Voziček je robusten, trpežen, lahek in enostaven za manevriranje
- Ogradnje, ročaji in predali so izdelani iz kakovostnega nerjavečega jekla AISI 340
- Zgornja površina je obdana s tristranim okvirjem, izdelanim iz ABS-a
- Vsi robovi so zaokroženi
- 4 kolesa Ø 125 mm, 2 kolesi z zavoro
- PVC odbijači nad kolesi
- Kolesa iz neslišne gume, ki ne puščajo sledi
  
- Izvedba je mogoča v različnih oblikah in dimenzijah
- Pripomočki in dodatki: predali, otroške previjalne blazine...

# WORK DESKS - CABINETS

## DELOVNI PULTI - OMARE

- Work desks and cabinets are made of different quality of stainless steel
- Made in various size and types:
  - Work desk with built-in single or double sink
  - Work desks with drawers
  - Work desk with sliding doors
- Different ways of mounting:
  - Standalone
  - Hanging
- Doors:
  - Full
  - Glazed (clear or sanded tempered glass)
- Various standard dimensions or dimensions according to order
- Usage: hospitals, veterinary facilities, pharmacy, sterilization, kitchen, unclean rooms, pathology, clinics, plaster rooms...
- Delovni pulti in omare so izdelani iz različnih kvalitetnih nerjavečih materialov
- Izvedba je mogoča v različnih oblikah in dimenzijah:
  - Delovni pulti z vgrajenim enojnim ali dvojnim koritom
  - Delovni pulti s predali
  - Delovni pulti z drsnimi vrati
- Montaža omar:
  - Samostoječe
  - Viseče
- Vrata:
  - Polna
  - Zastekljena (prozorno ali peskano kaljeno steklo)
- Izdelava po željah in potrebah naročnika ali s pomočjo naših nasvetov in predlogov
- Uporaba: bolnišnice, veterina, farmacija, sterilizacije, kuhinje, nečisti prostori, patologija, ambulante, mavčarne...

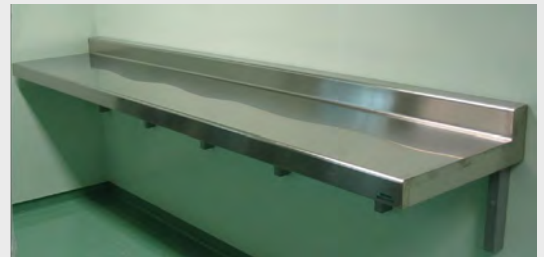

# TABLE FOR BABY CARE

## PULT ZA NEGO OTROKA

- Cabinet is made of plastic laminated clipboard, with slide or classic doors
- Table surface is made of Kerrock or ABS
- Fitted to 20 cm legs
  
- Made in various size and types:
  - With in-built baby bath-tub made of Kerrock or ABS
  - Built in mixer faucet
  
- Optional accessories:
  - Baby measure
  - Baby-changing cushion
  - Additional shelf for scales
  
- Dimensions:
  - Length: 1400-2700 mm
  - Width: 650 mm
  - Height: 900 mm
  - Dimensions can be adjusted according to order
  
- Omara je narejena iz plastičnega laminiranega odložišča, z drsnimi ali klasičnimi vrati
- Namizna plošča je narejena iz Kerroka ali ABS-a
- Vgrajene 20 cm noge
  
- Izvedba je mogoča v različnih oblikah in dimenzijah:
  - Z vgrajeno otroško kadjo iz Kerroka ali ABS-a
  - Z vgrajeno mešalno armaturo
  
- Dodatki:
  - Previjalna blazina
  - Dodatna polica za tehtnico
  - Merilo za merjenje otroka
  
- Dimenzije:
  - Dolžina: 1400-2700 mm
  - Širina: 650 mm
  - Višina: 900 mm
  - Dimenzije se prilagajajo po naročilu





# STAINLESS STEEL DESK FOR BABY CARE

## PULT ZA NEGO OTROKA IZ NERJAVEČEGA JEKLA

- Cabinet and table surface is made of stainless steel AISI 304
- All surfaces are smooth and easy to clean and enable high standard of hygiene maintenance
- Edges of the washer are rounded

- Made in various types:
  - With slide or classic door
  - With built-in baby bath tub
  - Built-in mixer faucet

- Accessories:
  - Baby measure
  - Baby changing cushion
  - Additional shelf for scales

- Dimensions:
  - Length: 1400 - 2700 mm
  - Width: 650 mm
  - Height: 900 mm

- Omara in površina mize sta narejeni iz kakovostnega nerjavečega jekla AISI 304
- Vse površine so gladke, omogočajo lahko čiščenje in visok standard vzdrževalne higiene
- Vsi robovi so zaokroženi

- Različne vrste:
  - Vgrajene omarice z drsnimi ali klasičnimi vrati
  - Vgrajena otroška kad
  - Vgrajena mešalna armatura

- Dodatki:
  - Previjalna blazina
  - Dodatna polica za tehtnico
  - Merilo za merjenje otroka

- Dimenzije:
  - Dolžina: 1400 - 2700 mm
  - Širina: 650 mm
  - Višina: 900 mm

# HYDRAULIC MAYO TABLE

## HIDRAVLIČNA INSTRUMENTARSKA MIZA - MAYO

- Mayo table is made entirely of stainless steel AISI 304
- Adjustable height by hydraulic cylinder from 900 to 1350 mm
- Top tray has a rim and can be removed from the stand
- Rotating top can be fixed in any position
- Antistatic wheels Ø 50 mm
  
- Dimensions:
  - 700 x 500 x 900 - 1350 mm
  - 600 x 400 x 900 - 1350 mm
  
- Weight of the table: 50 kg
  
  
- Instrumentarska miza je v celoti narejena iz kakovostnega nerjavečega jekla AISI 304
- Nastavljiva višina s hidravličnim cilindrom od 900 do 1350 mm
- Zgornja ploskev je poglobljena, zaobljena, z možnostjo snemanja
- Vrtljiv zgornji del se lahko nastavi v vseh položajih
- Antistatična kolesa Ø 50 mm
  
- Dimenzije:
  - 700 x 500 x 900 - 1350 mm
  - 600 x 400 x 900 - 1350 mm
  
- Teža mize: cca. 50 kg



# PACKING TABLE FOR DRY MATERIALS

## PAKIRNA MIZA ZA SUHE MATERIALE

- Top surface is made of plastic laminated chipboard
- The frame is made of stainless steel AISI 304 rectangular tubes
- Adjustable height for 25 mm
- Used for folding, packing and control of various sets or material
- Accesible on both sides, work can be done in sitting or standing positions
- Reinforcement of the frame 300 mm above the floor

- Dimensions:

- Length: 1200, 1600, 2000 or 2400 mm
- Width: 650 mm
- Height: 900 mm
- Dimensions can be adjusted according to order

- Zgornja površina je izdelana iz lesa, prevlečenega s plastičnim laminatom
- Okvir je izdelan iz pravokotnih cevnih profilov iz kakovostnega nerjavečega jekla AISI 304
- Nastavljiva višina za 25 mm
- Uporablja se za zlaganje, pakiranje in nadzor različnih setov
- Dostopnost iz obeh strani, delo je mogoče v sedečem ali stoječem položaju
- Ojačitev okvirja 300 mm nad tlemi

- Dimenzije:

- Dolžina: 1200, 1600, 2000 ali 2400 mm
- Višina: 650 mm
- Širina: 900 mm
- Dimenzije se prilagajajo po naročilu



# DOUBLE PACKING TABLE FOR DRY MATERIALS

## DVOJNA PAKIRNA MIZA ZA SUHE MATERIALE

- Top surface is made of plastic laminated chipboard
- The frame is made of stainless steel AISI 304 rectangular tubes
- Adjustable height for 20 mm
- Cabinet with drawers on both sides of the table
- Three sockets mounted on the shelving unit on the top of the table

- Used for folding, packing and control of various sets of material
- Accesible on both sides, work can be done in sitting or standing positions

- Dimensions:

- Packing table: 2000 x 1400 x 900 mm
- Top shelf: 2000 x 600 mm
- Lower shelf: 1870 x 700 mm
- Dimensions can be adjusted according to order

- Zgornja površina in police so izdelane iz lesa, prevlečenega s plastičnim laminatom
- Okvir je izdelan iz pravokotnih cevnih profilov iz kakovostnega nerjavečega jekla AISI 304
- Nastavljiva višina za 20 mm
- Dva predalnika s predali na obeh straneh mize
- Tri vtičnice na regalni enoti

- Uporablja se za zlaganje, pakiranje in nadzor različnih sklopov materiala
- Dostopnost iz obeh strani, delo je mogoče v sedečem ali stoječem položaju

- Dimenzije:

- Pakirna miza: 2000 x 1400 x 900 mm
- Zgornja polica: 2000 x 600 mm
- Spodnja polica: 1870 x 700 mm
- Dimenzije se prilagajajo po naročilu





# WORKING TABLE FOR WET MATERIALS

## DELOVNA MIZA ZA MOKRE MATERIALE

- Working table for wet materials is made entirely of stainless steel
- AISI 403
- Usage: putting materials into wire baskets and containers, depositing and storage of materials
- All surfaces are smooth and easy to clean and enable high standard of hygiene maintenance
- All edges are rounded
- Possibility of height adjustment for 25 mm
- Reinforcement of the frame 300 mm above the floor

- Dimensions:

- Length: 1200, 1600 or 2000 mm
- Width: 650 mm
- Height: 900 mm
- Dimensions can be adjusted according to order

- Delovna miza za mokre materiale je v celoti izdelana iz kakovostnega nerjavečega jekla AISI 403
- Uporaba: pakiranje materialov v žičnate košare in posode, ter odlaganje in skladiščenje materiala
- Vse površine so gladke, omogočajo lahko čiščenje in visok standard vzdrževalne higiene
- Vsi robovi so zaokroženi
- Nastavljiva višina za 25 mm
- Ojačitev okvirja 300 mm nad tlemi

- Dimenzije:

- Dolžina: 1200, 1600 ali 2000 mm
- Višina: 650 mm
- Širina: 900 mm
- Dimenzije se prilagajajo po naročilu



# WORKING TABLE FOR WET MATERIALS WITH SINKS

## DELOVNA MIZA ZA MOKRE MATERIALE S POMIVALNIMI KORITI

- Working table for wet materials with double sink is intended for stacking, manual washing and preparation
- Working surface, shelves, sinks and table frame are made entirely of stainless steel AISI 403
- All surfaces are smooth and easy to clean and enable high standard of hygiene maintenance
- All edges are rounded
- Possibility of height adjustment for 25 mm
- Each unit has a brass valve for drain
- Possibility of placing the mixer on sinks
- Lower shelf is intended for storage

- Dimensions:
  - 2000 x 650 x 900 mm
  - Dimensions can be adjusted according to order

- Delovna miza za mokre materiale z dvojnimi koritoma je namenjena zlaganju, ročnemu pranju in pripravi materiala
- Delovna površina, polica, korita in okvir mize so izdelani iz kakovostnega nerjavečega jekla AISI 304
- Vse površine so gladke, omogočajo lahko čiščenje in visok standard vzdrževalne higiene
- Vsi robovi so zaokroženi
- Miza je nastavljiva po višini za cca. 25 mm
- Vsako korito ima medeninasti ventil za izpust
- Možnost namestitve mešalne armature na korita
- Spodnja polica je namenjena skladiščenju

- Dimenzije:
  - 2000 x 650 x 900 mm
  - Dimenzije se prilagajajo po naročilu



# DISSECTING TABLE

## SECIRNA MIZA

- The unit is designed as multi-purpose workstation, suitable for the dissection of large and small animals
- Working surface and frame are made entirely of stainless steel AISI 403
- All surfaces are smooth and easy to clean and enable high standard of hygiene maintenance
- All edges are rounded
- Raised edge around a work area, inside the edge is drainage channel
- Anti-noise cover positioned under the work surface
- Three removable perforated worktops on the working surface
- Flusher of working surface is installed below the perforated top surface and has a constant flow with pressure control
- Ventilation allows gas draining down through a vertical circular outlet
- The installation is made of chrome-plated brass
- Single sink with mixer valve and flexible hose for flushing, placed on the side of table
- Socket for 220-240 V
- Usage: veterinary medicine, pathology, forensic medicine...

- Enota je načrtovana kot večnamenska delovna postaja, primerna za disekcijo večjih in manjših živali
- Delovne površine in ogrodje so izdelani iz kakovostnega nerjavečega jekla AISI 304
- Vse površine so gladke, omogočajo lahko čiščenje in visok standard vzdrževalne higiene
- Vsi robovi secirne mize so zaokroženi
- Dvignjen rob okoli delovne površine, znotraj roba kanal za odtekanje
- Protihrupna prevleka nameščena pod delovno površino
- Tri snemljive perforirane delovne plošče na delovni površini
- Izplakovalnik delovne površine je nameščen pod perforirano zgornjo ploskvijo in ima stalen pretok s kontrolo pritiska
- Ventilacija omogoča odtekanje plinov navzdol skozi vertikalni krožni izpuh
- Napeljava je izdelana iz kromirane medenine
- Enojno korito z mešalno armaturo in fleksibilno cevjo za splakovanje, nameščeno ob stani mize
- Vtičnica za 220-240 V
- Uporaba: veterina, patologija, sodna medicina...





# WALL SHELVES

## STENSKE POLICE

- Double shelves for the purpose of storage and disposal of the instrument boxes and containers
- Mounting above the working surface
- Shelves are made of stainless steel AISI 304
- Shelves are strong and durable
- All surfaces are smooth and easy to clean and enable high standard of hygiene maintenance
- Edges of shelves are rounded
- Shelves are mounted on stainless steel profiles, the height of the shelf can be adjusted
- Dimensions:
  - Length: 1200, 1600, 2000 or 2400 mm
  - Width: 300 mm
  - Or according to order



- Dvojne stenske police so namenjene shranjevanju in odlaganju inštrumentarskih košaric in kontejnerjev
- Montaža nad delovno površino
- Police so narejene iz kakovostnega nerjavečega jekla AISI 304
- Police so močne in vzdržljive
- Vse površine so gladke, enostavne za čiščenje in omogočajo visok standard vzdrževalne higiene
- Vsi robovi so zaokroženi
- Police so pritrjene na profil iz nerjavečega jekla, višina police je prilagodljiva po višini nosilcev
- Dimenzije:
  - Dolžina: 1200, 1600, 2000 ali 2400 mm
  - Širina: 300 mm
  - Ali po naročilu



# WALL PROFILES WITH BASKETS AND SHELVES

## STENSKI OBEŠALNI PROFILI S KOŠARAMI IN POLICAMI

- Hanging wall profiles are made of square or rectangular stainless steel profiles
- Profiles are fitted with handles for hanging baskets or shelves made of stainless steel or wire
- Baskets are purpose of storage pure linen, masks, caps...

- Dimensions of baskets:

- 600 x 300 x 300 mm
- 600 x 300 x 150 mm

- Dimensions of shelves:

- 600 x 300 x 30 mm

- We made individual sets according to order

- Stenski obešalni profili so izdelani iz kvadratnih oz. pravokotnih nerjavečih cevni profilov
- Profili so opremljeni s klukicami za obešanje košar ali polic iz nerjaveče pločevine ali žice
- Košare so namenene shranjevanju čistega OP perila, mask, kap in podobno

- Dimenzije košar:

- 600 x 300 x 300 mm
- 600 x 300 x 150 mm

- Dimenzije polic:

- 600 x 300 x 30 mm

- Po naročilu izdelamo posamezne komplete



# SHELVING SYSTEM

## SISTEMSKI REGALI

- Shelves are made of chromed steel
- Mesh shelves are adjustable in height
- Fixed and transport racks - the possibility of different combinations
- Shelving can easily be linked together into a single system

- Dimensions:

- Length: 600, 900, 1200, 1500 or 1800 mm
- Height: 1750 mm
- Depth: 350, 450 ali 600 mm



- Regali so izdelani iz kromiranega jekla
- Police so mrežaste, nastavljive po višini
- Fiksni in prevozni regali - možnost različnih kombinacij
- Regale lahko med seboj enostavno povežemo v enoten sistem

- Dimenzije:

- Dolžina: 600, 900, 1200, 1500 ali 1800 mm
- Višina: 1750 mm
- Globina: 350, 450 ali 600 mm



# STAINLESS STEEL CABINETS

## OMARE IZ NERJAVEČEGA JEKLA

- Cabinets are strong and durable
- Frame, doors, shelves and feet are made of stainless steel AISI 304
- All outside and inside surfaces are smooth and easy to clean and enable high standard of hygiene maintenance
- Edges of the cabinets are rounded
- Types of cabinets: high cabinets, wall cabinets, low cabinets, single cabinets, double cabinets, built-in closets, cabinets for urin jars storage or made according to order
- Types of doors: stainless steel doors, tempered glass doors, framed glass doors...
- Dimensions: various standard dimensions or dimensions according to order
- Usage: hospitals, operating rooms, surgery, unclean areas, sterilizations, clinics...



- Omare so močne in vzdržljive
- Okvir, vrata, police in noge so narejene iz kakovosnega nerjavečega jekla AISI 304
- Vse zunanje in notranje površine so gladke, lahke za čiščenje in omogočajo visok standard vzdrževalne higiene
- Vsi robovi omar so zaokroženi
- Vrste omar: samostoječe, viseče, vgradne, podpultne ali narejene po naročilu
- Vrste vrat: vrata iz nerjavečega jekla, steklena (prozorno ali peskano kaljeno), uokvirjena steklena vrata...
- Dimenzije: različne standardne dimenzije ali dimenzije glede na želje in potrebe naročnika
- Uporaba: bolnišnice, operacijske dvorane, kirurgija, nečisti prostori, sterilizacije, ambulate...



# BEDPAN WASHER DISINFECTOR BLATEX

## DEZINFEKCIJSKI PRALNI STROJ IN IZLIVNIK

- Washer disinfector is made of stainless steel AISI 304
- All surfaces are smooth and easy to clean and enable high standard of hygiene maintenance
- Edges of the washer are rounded
- Used for emptying, washing and steam disinfection of bedpans and other medical equipment
- Built-in steam disinfector
- Three different washing programs
- Temperature of steam disinfection up to 94 °C
- Digital display showing disinfection temperature
- All functions, disinfection, temperature and time are controlled by microprocessor
- Built-in pump and reservoir make sure the quality of washing is not depending on water pressure from water supply and prevent polluted water in-burst
- Dosing device automatically adds disinfectant liquid, quantity of detergent is adjustable
- Drain: Ø 100 mm
- Top loading
- Weight: 65 kg
- Machines are simple to use and functional
- Standing or console variety possible
- Dimensions: 600 x 600 x 900 mm

- Dezinfekcijski pralni stroj je narejen iz kakovostnega nerjavečega jekla AISI 304
- Vse površine so gladke, omogočajo lahko čiščenje in visok standard vzdrževalne higiene
- Vsi robovi pomivalca so zaokroženi
- Uporablja se za praznjenje, pranje in parno razkuževanje nočnih posod in ostale zdravniške opreme
- Vgrajen parni dezinfektor
- Trije različni pralni programi
- Temperatura parnega razkuževanja seže do 94 °C
- Na digitalnem displeju je vidna temperatura razkuževanja
- Vse funkcije, razkuževanje, temperaturo in čas pranja, nadzira mikroprocesor
- Vgrajena vodna pumpa in rezervoar omogočata kakovostno pranje, neodvisno od vodnega tlaka iz vodovoda in preprečuje, da bi vanj prišla onesnažena voda
- Dozirna naprava samodejno dodaja razkuževalno tekočino, količina detergenta je nastavljiva
- Odtok: Ø 100 mm
- Nalaganje z vrha
- Teža: 65 kg
- Stroji so preprosti za uporabo in zelo funkcionalni
- Možnost samostoječe ali konzolne vgradnje
- Dimenzije: 600 x 600 x 900 mm

### TEHNICAL DATA

- Voltage: 230 V, 50 HZ
- Power: 4150 W
- Heating power: 4000 W
- Pump power: 1000 W
- Fuse: 20 A
- Water supply: hot water R 3/4", cold water R 3/4"
- Water pressure: min. 1 bar
- Drain: ND Ø 100 (floor or wall)
- Water consumption: 36 l/cycle programmes 1 and 2, 5.5 l/cycle programme 3



### TETEHNIČNI PODATKI

- Napetost: 230 V, 50 HZ
- Moč: 4150 W
- Grelna moč: 4000 W
- Črpalna moč: 1000 W
- Varovalka: 20 A
- Oskrba z vodo: topla voda R 3/4", hladna voda R 3/4"
- Vodni pritisk: min. 1 bar
- Odtok: ND Ø 100 (talni ali stenski)
- Poraba vode: 36 l/ciklusni program 1 in 2, 5.5 l/ciklusni program 3





# DUMP BASIN

## IZLIVNIK

- Dump basin is made of stainless steel AISI 304
- All surfaces are smooth and easy to clean and enable high standard of hygiene maintenance
- Edges of the washer are rounded
- Used for pouring off denser waste liquids, washing pans and medical equipment
- Stainless steel grid in the sink
- Drain: Ø 100 mm
- Fitting to the side of bedpan washer
- Weight: 25 kg
  
- Varieties: with or without mixer faucet



- Izlivnik je narejen iz kakovostnega nerjavečega jekla AISI 304
- Vse površine so gladke, enostavne za čiščenje in omogočajo visok standard vzdrževalne higiene
- Vsi robovi izlivnika so zaokroženi
- Uporaben za izlitje gostejših odpadnih tekočin, pranje posod in ostale medicinske opreme
- Mreža v pomivalnem koritu je iz nerjavečega jekla
- Odtok: Ø 100 mm
- Prilegajoč pomivalcu nočnih posod
- Teža: 25 kg
  
- Različne vrste: z ali brez mešalne armature

# SURGICAL SCRUB SINKS

## KIRURŠKA KORITA

- Surgical scrub sinks are made of high quality stainless steel AISI 304
- Available in different types and sizes:
  - The scrub units can be equipped with various mixer faucets:
    - Hand actuated faucet
    - Elbow actuated
    - Automatic mixer with electric or battery photocell
- Accessories: detergent and disinfectant dispenser and brush dispenser, mirrors in a frame, used brushes bowl...
- Dimensions:
  - Length:
    - 800 mm - one station scrub sink
    - 1400 mm - two stations scrub sink
    - 1950 mm - three stations scrub sink
    - Or according to order up to length of 3000 mm
  - Height:
    - 950 or 1150 mm - wall mounted version
    - 1400 mm - self standing scrub sink
  - Width: 555 mm
- Kirurška korita so narejena iz visoko kvalitetnega nerjavečega jekla AISI 304
- Na voljo v različnih velikostih in vrstah:
  - Čistilne enote so lahko opremljene z različnimi mešalnimi armaturami
    - Klasična armatura z ročno aktivacijo
    - Armatura z komolčno aktivacijo - termostatska
    - Avtomatska mešalna armatura - termostatska z avtomatskim vklopom
- Dodatki in pripomočki: dispenzer za milo in dezinfekcijsko sredstvo, dispenzer za sterilne ščetke, ogledala v okvirjih, posoda za porabljene ščetke ...
- Dimenzije:
  - Dolžina:
    - 800 mm - enojno kirurško korito
    - 1400 mm - dvojno kirurško korito
    - 1950 mm - trojno kirurško korito
    - Po naročilu do dolžine 3000 mm
  - Višina:
    - 950 ali 1150 mm - stenska različica
    - 1400 mm - samostoječe korito
  - Širina: 555 mm

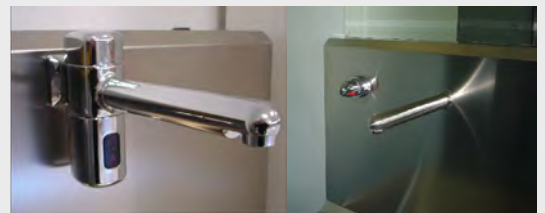

# SOAP / DISINFECTANT DISPENSER

## DISPENZER ZA MILO / RAZKUŽILO

- Dispenser is made entirely of stainless steel AISI 304
- Enable hygienic use (elbow actuated)
- Simple mounting
- Suitable for different types of soap/disinfectant bottles
  
- Usage: hospitals, veterinary facilities, pharmacology, operating rooms, surgery, sterilizations, kitchens, cleaning areas, pathology, clinics...



- Dispenser je v celoti narejen iz kakovostnega nerjavečega jekla AISI 304
- Omogoča higijenično uporabo (sprožanje z komolcem)
- Enostavna montaža
- Primeren za različne vrste flašk mila in razkužil
  
- Uporaba: bolnišnice, veterina, farmacija, operacijske dvorane, kirurgija, sterilizacije, bolniške sobe, kuhinje, nečisti prostori, patologija, ambulante, mavčarne...

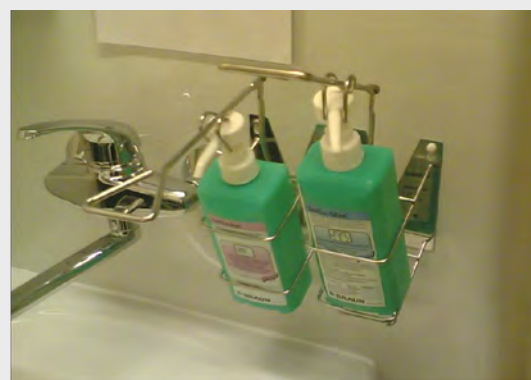

# STERILE BRUSHES DISPENSER

## DISPENZER ZA STERILNE ŠČETKE - STERILKA

- Intendet to provide a required number of sterile brushes for washing hands in surgery
- Dispenser is made entirely of stainless steel AISI 304
- It contains a holder, mounted on the wall and the cassette for the sterile brushes
- Capacity: 20 sterile brushes
  
- Dimensions:
  - Dispenser: 616 x 150 x 45 mm
  - Dispenser holder: 400 x 135 x 52 mm

- Namenjena je zagotavljanju zadostnega števila sterilnih ščetk za umivanje rok v kirurgiji
- Dispenser je v celoti narejen iz kakovostnega nerjavečega jekla AISI 304
- Sestavljena je iz nosilca, ki je pritrjen na steno in iz kasete, v kateri se ščetke sterilizirajo
- Kapaciteta: 20 sterilnih ščetk
  
- Dimenzije:
  - Dispenser: 616 x 150 x 45 mm
  - Nosilec za dispenser: 400 x 135 x 52 mm



# WASTE BAG HOLDER

## DRŽALO ZA PVC VREČKE

- Waste bag holder (frame) is made entirely of stainless steel AISI 304
- Highly practical, enables easy hygiene maintenance
- Different ways of mounting:
  - Mounting to the wall
  - Fitting to the trolley
  - Fitting to the stainless steel bar
  - According to order we can adjust the frame for fitting to the hospital bed, different stands...
- Different dimensions:
  - 235 x 175 mm
  - 235 x 130 mm
- Instructions for mounting the bag:  
Lift the fitting frame, adjust the bag into the holding frame and fix the bag with closing the fitting frame.
- Usage: public spaces, hospitals, clinics, nursery homes...
- Nosilec vreč za odpadke (okvir) je v celoti narejen iz kakovostnega nerjavečega jekla AISI 304
- Je zelo praktičen, omogoča enostavno vzdrževanje higiene
- Različni načini montaže:
  - Pritrditev na steno
  - Pritrditev na voziček
  - Pritrditev na letev debeline 5-15 mm
  - Po naročilu lahko okvir prilagodimo bolniškim posteljam, različnim stojalom...
- Različne dimenzije:
  - 235 x 175 mm
  - 235 x 130 mm
- Navodila za namestitev vreče:  
Dvignemo pritrdilni obroč, vrečko vstavimo v nosilni okvir tako, da zgornji rob vrečke zavijamo preko nosilnega okovja. Zgornji rob vrečke pritrdimo s pritrdilnim obročem.
- Uporaba: javni prostori, bolnišnice, ambulante, negovalni domovi za ostarele...



# HEATED BOWL HOLDER

## PREVOZNO STOJALO Z GRELCEM IN POSODO

- Holder and the bowl made of stainless steel AISI 304
- Height adjustment with pneumatic system from 1050 to 1350 mm
- 5 antistatic wheels, non-marking and noiseless
- 2 wheels with brake
- Temperature adjustment via push button, from 35 to 60 °C
- Led display for temperature monitoring
- Used for physiological and other fluids heating
  
- Dimensions: 650 x 1050 - 1350 mm
  
- Usage: hospitals, veterinary facilities, pharmacology, operating rooms, surgery, sterilizations...



- Stojalo in posoda sta narejena iz kakovostnega nerjavečega jekla AISI 304
- Pnevmatični sistem nastavitve višine od 1050 do 1350 mm
- 5 antistatičnih, neslišnih koles, ki ne puščajo sledi
- 2 kolesi z zavoro
- Temperatura se uravnava s pomočjo gumba od 35 do 60 °C
- Led zaslon za spremljanje temperature
- Uporablja se za gretje fizioloških in ostalih tekočin
  
- Dimenzije: 650 x 1050 - 1350 mm
  
- Uporaba: bolnišnice, veterina, farmacija, operacijske dvorane, kirurgija, sterilizacija...



# BARRIER CURTAINS

## PREGRADNE ZAVESE

- Barrier curtains for patient rooms and clinics
- Telescopic extension arms
- Single, double or triple curtain rails
- Curtain fabrics suitable for use in hospitals (Bioactive)

### Barrier curtains on telescopic extension arms

- Made of stainless steel AISI 304 or aluminium
- Standard dimensions 880-2060 mm, or according to order
- Different ways of mounting:
  - Mounting to the wall
  - Mounting to the stainless steel bar
  - Made according to order

### Barrier curtains on single, double or triple curtain rails

- Rails are made of aluminium
- Fitting of the rails to the ceiling or arm extensions
- Usage: hospitals, clinics, nursery homes, patient rooms...

- Pregradne zavese za bolniške sobe ali ambulante
- Teleskopsko raztegljiva roka
- Enojno, dvojno ali trojno vodilo
- Zavesno blago je primerno za bolnišnično rabo (Bioaktivno)

### Pregradne zavese na teleskopskih vodilih

- Narejene iz kakovostnega nerjavečega jekla AISI 304 ali aluminija
- Standardne dimenzije 880-2060 mm, ali po naročilu
- Različni načini montaže:
  - Pritrditev na steno
  - Pritrditev na stensko letev s prižemo
  - Pritrditev po naročilu

### Pregradne zavese na enojnem ali večkanalnem vodilu

- Vodila so narejene iz aluminija
- Pritrditev vodila na strop ali na nosilce
- Uporaba: bolnišnice, ambulante, negovalni domovi za ostarele, bolniške sobe...



# MULTIFUNCTIONAL HANDRAILS

## VEČNAMENSKA OPRIJEMALA

- Handrails are made of powder-coated steel or stainless steel AISI 304
- Colour chosen by the customer
- Installation in the sanitary facilities at the sink, toilet, shower...
- Invisible fixing or with rosette

- Implementation is possible in different shapes and sizes:

- Straight
- The L-shaped
- Console - fixed
- Console - lifting
- Adjustable height console

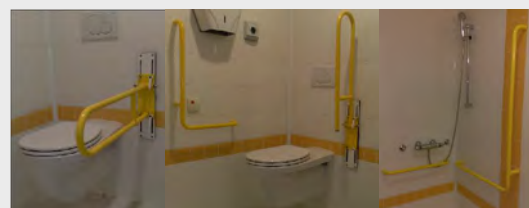
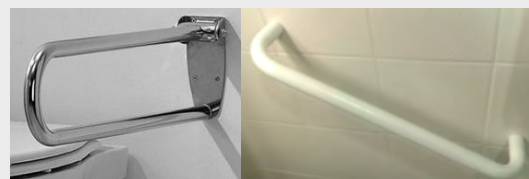

- Orijemala so izdelana iz prašno barvanega jekla oz. iz kakovostnega nerjavečega jekla AISI 304
- Barva po izbiri naročnika
- Namestitev v sanitarno toaletne prostore ob umivalnik, WC školjko, tuš in podobno
- Nevidna pritrditev ali pritrditev z rozeto

- Izvedba je mogoča v različnih oblikah in dimenzijah:

- Ravne
- V obliki črke L
- Konzolne - fiksne
- Konzolne - dvižne
- Nastavljiva konzola po višini

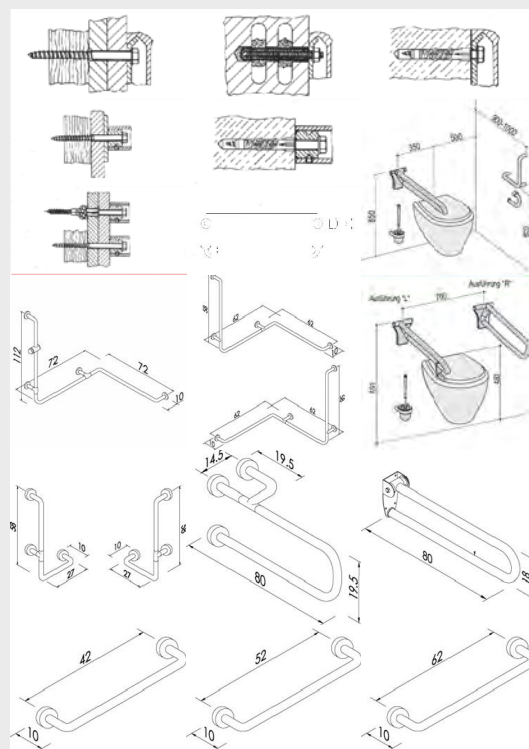



# STAINLESS STEEL RAILINGS

## OGRAJE IZ NERJAVEČEGA JEKLA

- Railings are made of stainless steel AISI 304
- Handrails can be made in different materials such as stainless steel, wood or plastic
- Implementation is possible in different shapes and sizes:
  - The interior rails
  - External rails
  - Balcony rails
- Making according to order or using our tips and suggestions

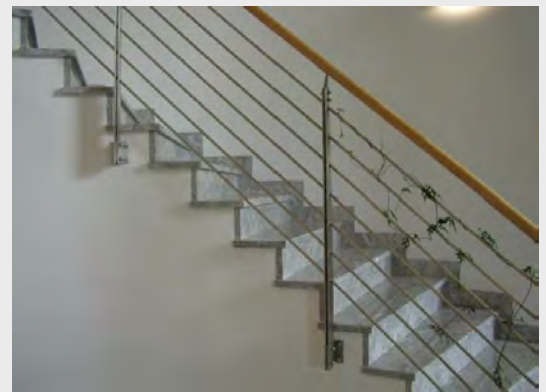

- Ograje so izdelane iz kakovostnega nerjavečega jekla AISI 304
- Orijemala so lahko izdelana v različnih materialih, kot je nerjaveče jeklo, les ali plastika
- Izvedba je mogoča v različnih oblikah in dimenzijah:
  - Notranje stopniščne ograje
  - Zunanje stopniščne ograje
  - Balkonske ograje
- Izdelava po željah naročnika ali s pomočjo naših nasvetov in predlogov

